

MecALAC

TLB880
SIDESHIFT - TECHNICAL DATA



TLB880

BACKHOE LOADERS-SIDESHIFT - TECHNICAL DATA
EU STAGE V / U.S. EPA TIER 4 FINAL

MecALAC



TLB880

SIDESHIFT BACKHOE LOADER

LOADER SIDE

- A** High Breakout force and (42kN / 9442lbf) tear-out force (46kN / 10341lbf), exceptional lifting capacity (3700kg / 8157lbs) to full height
- B** Unique single centrally located bucket cylinder to provide the best amplitude and breakout force over the market with minimal maintenance
- C** 1M³(1.3 yd³) or 1.2m³(1.57 yd³) bucket available in standard or 7-in-1 form
- D** Optional Ride Control loader suspension to improve safety and comfort at high speed





LED WORKLIGHTS
4 FRONT AND 4 REAR
AS STANDARD

OPENING REAR QUARTER
WINDOWS FOR IMPROVED
VENTILATION AND
TRENCHING VISIBILITY

UP AND OVER
REAR WINDOW
FOR EXCELLENT
VENTILATION

POWER-ASSISTED
BRAKES OFFER
EXCELLENT BRAKING
WITH REDUCED
OPERATOR EFFORT

BACKHOE SIDE

Exceptional performances:

Tearout force up to 42kN (9442lbf)

E Break-out force up to 69kN (15512lbf)

Digging reach up to 7m (22'11")

Digging depth up to 5.7m (18'10")

F Robust straight boom type to ensure a clear view
when trenching

G Externally adjustable dipperstick wear pads for easy
servicing and replacement

H Dual transport lock of the boom and slew functions
from inside the cab to ensure safety on road

I New slew system provides high torque for easier
backfilling and slewing uphill

J Externally adjustable stabiliser wear pads for easy
servicing and replacement

K Standard Mechanical controls of the backhoe with
the choice of SAE, ISO and diagonal drive mode

TECHNICAL DATA TLB880 - STAGE V / TIER 4 FINAL

BACKHOE DIMENSIONS*		Standard Dipper	Deep Dig Dipper		
			Retracted	Retracted	Extended
A	Dig depth	Maximum SAE	4401 mm (14'5")	4401 mm (14'5")	5744 mm (18'10")
		60 cm (2 ft) Flat Bottom SAE	4388 mm (14'4")	4388 mm (14'4")	5731 mm (18'8")
B	Reach – ground level to slew		5725 mm (18'9")	5725 mm (18'9")	6995 mm (22'11")
C	Loading reach		1740 mm (5'8")	1740 mm (5'8")	2672 mm (8'9")
D	Operating height		5623 mm (18'5")	5323 mm (17'6")	6606 mm (21'8")
E	Loading height SAE		3963 mm (13')	3963 mm (13')	4939 mm (16'2")
	Max dumping height		3884 mm (12'9")	3884 mm (12'9")	4859 mm (15'11")
F	Straight wall dig depth		2557 mm (8'5")	2557 mm (8'5")	3714 mm (12'2")
G	Bucket rotation degrees	Speed	194	194	194
		Power	163	163	163
Stabiliser spread			2290 mm (7'6")	2290 mm (7'6")	2290 mm (7'6")
Maximum levelling angle degrees			6	6	6

*Includes standard 600 mm (2') HD bucket.

LOADER DIMENSIONS		Standard / 7 in 1 Bucket
N	Dump clearance – at 45°	2722 mm (8'11")
O	Loader height	3262 mm (10'8")
P	Hinge pin height	3510 mm (11'6")
Q	Pin forward reach	385 mm (1'3")
R	Reach at ground	1454 mm (4'9")
S	Max. reach at full height	1214 mm (3'12")
T	Reach at full height – at 45°	732 mm (2'5")
U	Dig depth	134 mm (0'5")
	Rollback at ground	42.4°
V	Maximum dump angle fully raised	49.6°
	Overall operating height	4412 mm (14'6")

BACKHOE PERFORMANCE		Standard Dipper	Deep Dig Dipper			
			Retracted		Extended	
		Standard Bucket HD Bucket	Standard Bucket HD Bucket	Standard Bucket HD Bucket	Standard Bucket HD Bucket	Standard Bucket HD Bucket
Max slew torque kNm (lbf-ft)		20.7 (15267)	20.7 (15267)	20.7 (15267)	20.7 (15267)	20.7 (15267)
Dipper tearout kN (lbf) (SAE J49 Standard)		42.2 (9487) 42.2 (9487)	42.2 (9487) 42.2 (9487)	42.2 (9487) 42.2 (9487)	28.7 (6452) 28.7 (6452)	28.7 (6452) 28.7 (6452)
Bucket tearout kN (lbf)	Speed	60 (13489) 60 (13489)	60 (13489) 60 (13489)	60 (13489) 60 (13489)	60 (13489) 60 (13489)	60 (13489) 60 (13489)
	Power	N/A 68.7 (15444)	N/A 68.7 (15444)	N/A 68.7 (15444)	N/A 68.7 (15444)	N/A 68.7 (15444)

LOADER PERFORMANCE		Standard Bucket	7 in 1 Bucket
Bucket breakout* kN (lbf)		42.0 (9442)	41.8 (9397)
Arms breakout* kN (lbf)		45.4 (10206)	41.6 (9352)
Lift capacity to full height** kg (lbs)		3699 (8155)	3249 (7163)
Rated operating capacity ISO 14397		Hydraulic Limited 2784 (6137)	Stability Limited 2559 (5641)

*Loader specifications are stated in accordance with ISO 14397 and EN474 Part 4.

**Based on basic machine configuration; cab, standard loader bucket, standard dipper stick, 24 in | 600 mm bucket, full fuel tank.

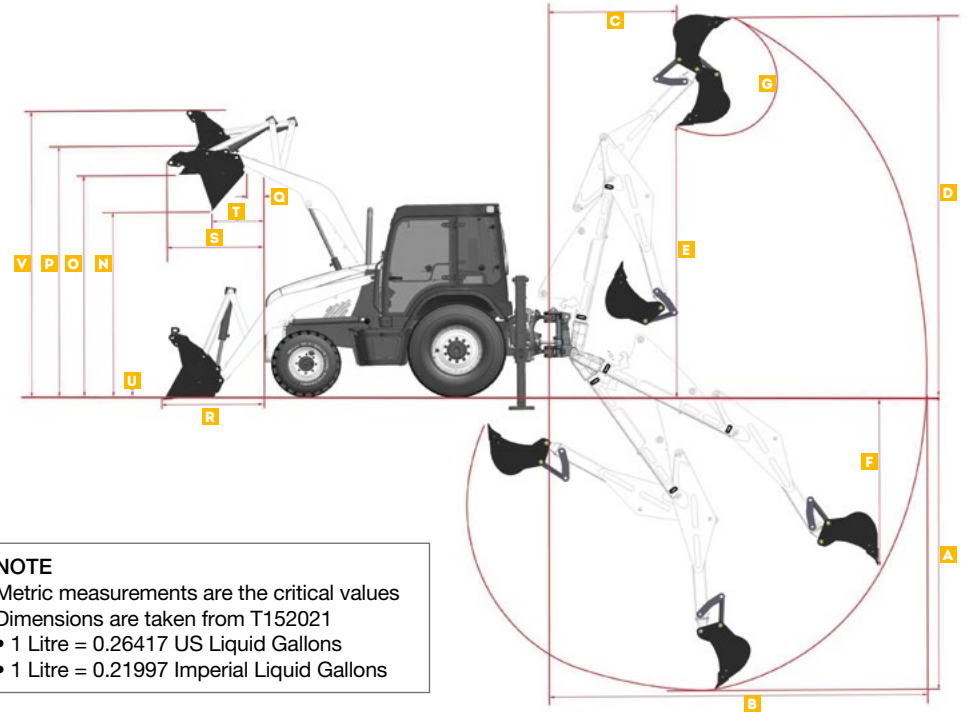

NOTE
Metric measurements are the critical values
Dimensions are taken from T152021
• 1 Litre = 0.26417 US Liquid Gallons
• 1 Litre = 0.21997 Imperial Liquid Gallons

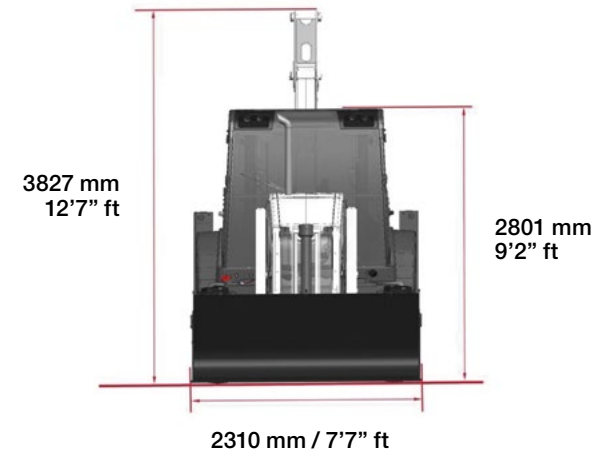

Note: image is for reference purpose only

TECHNICAL DATA TLB880 - STAGE V / TIER 4 FINAL

ENGINE

	Wastegate turbocharger with charge air cooling
	Torque rise 38%
Perkins 904J-E36TA	Electronic fuel injection
EU Stage V / U.S. EPA Tier 4 Final*	Stainless steel muffler and Exhaust Stack (DOC, SCR & DPF Exhaust System)
	500 hours service period
Cylinders	4
Capacity	3.6 L (221 in ³)
Rated speed	2200 rpm
Gross power @ 2200 rpm cert. rating to UN/ECE R120	74.5 kW (100 hp)
Derived net rating @ 2200 rpm to ISO/80/1269/EC	68.8 kW** (94 hp**)
Max Torque @ 1500 rpm	
UN/ECE R120	430 Nm (317 lb.ft)
Derived NET Torque	403 Nm (297 lb.ft)

*Depending on your Local Legislation - Environmental Protection Agency (EPA) - **Nominal non-certified values.

ELECTRICAL SYSTEM

Wiring and connectors meet IP69 standard	
Maintenance free battery	
12 volt negative ground	
Battery isolator	
Jump start posts	
85 amp alternator	
Blade type fuses	
110 A/hr single battery with 920 CCA – EN Standard	

CAPACITIES

	Ltrs (gals)
Fuel tank	135.0 (29.6)
Adblue Tank	19.0 (4.2)
Engine coolant	14.0 (3.7)
Engine oil (including filter)	9.0 (2.0)
Servo power synchro transmission	18.0 (4.0)
Synchro shuttle transmission	18.0 (4.0)
Rear axle (including final drives)	15.5 (3.4)
Front axle (including final drives)	9.5 (2.1)
Hydraulic tank	87.5 (19.2)

AXLES AND BRAKES

Outboard planetary final drives for easier servicing			
Foot operated differential lock with 100% lockup			
16° front axle oscillation to maintain maximum ground contact and traction			
High capacity outboard mounted wet disc brakes			
Self equalizing and self adjusting			
Internal wet disc parking brake			
Selectable 2 or 4 wheel braking			
Axle Ratings	Max Static Loading	Max Dynamic Loading	
Front kN (lb)	225 (50582)	90 (20259)	
Rear kN (lb)	187.5 (42152)	75 (16867)	

TURNING CIRCLES

	Over Tyres	Over Bucket
Without brakes m (ft)	7.9 (26')	10.8 (35'8")
With brakes m (ft)	7.0 (23')	10.0 (33')

TRANSMISSION

4 speed synchro shuttle gearbox

Modulated forward and reverse clutch packs enable smooth direction changes			
De-clutch button on shift lever			
Direction control with neutral safety interlock			
Single stage torque converter with 3.01:1 stall ratio			
Tyres	Front:	12.5/80 x 18 12 PR TR-09 IND	
	Rear:	16.9 x 28 12 PR TI-06 IND	
Travel Speeds		Forward/Reverse Km/h (mph)	
1st		5.9 (4)	
2nd		9.5 (6)	
3rd		20.2 (13)	
4th		40 (25)	

4 speed servo power synchro

Automatic and manual shifting			
Push button kickdown and kick up in 1st and 2nd gear			
Automatic shifting between 4th, 3rd and 2nd			
Single stage torque converter with 3.01:1 (Standard SPS)			
Tyres	Front:	12.5/80 x 18 12 PR TR-09 IND	
	Rear:	16.9 x 28 12 PR TI-06 IND	
Travel Speeds		Forward Km/h (mph)	
1st		5.9 (4)	
2nd		9.5 (6)	
3rd		20.2 (13)	
4th		40 (25)	
Travel Speeds		Reverse Km/h (mph)	
1st		5.9 (4)	
2nd		9.5 (6)	
3rd		20.2 (13)	

HYDRAULIC SYSTEM

Tandem gear pumps with unloader valve	
Closed centre control valves	
External oil level gauge	
125 micron suction strainer	
10 micron return line filter	
10 micron filter breather	
Main pump flow @ 2200 rpm l/min (gpm US/gpm)	85 (22/19)
Secondary pump flow @ 2200 rpm l/min (gpm US/gpm)	58 (15/13)
System main relief setting bar (psi)	250 (3626)

OPERATING WEIGHTS

Base Machine Weight* kg (lb)	8060 (17769)
7in1 Multipurpose Bucket (1.2m ³) kg (lb)	+337 (743)
Loader Bucket Fork Kit kg (lb)	+153 (337)
Deep Dig Dipper kg (lb)	+217 (478)
ROPS Frame kg (lb)	-128 (282)



*Base operating weight includes cab, standard bucket, standard dipper, 600 mm (24") bucket, full tank of fuel and a 75kg (165 lb) operator

➤ TECHNICAL DATA TLB880 - STAGE V / TIER 4 FINAL

TYRES	
Mitas 18" Front - 28" Rear	
Mitas 18" Front - 26" Rear	
Mitas 20" Front - 26" Rear (Industrial)	
Mitas 20" Front - 30" Rear (Industrial)	
Michelin 20" Front - 28" Rear (Semi-industrial)	
Michelin 20" Front - 30" Rear (Semi-industrial)	
Michelin 18" Front - 28" Rear	
Michelin 18" Front - 26" Rear	

PALLET FORKS	Standard / 7 in 1 Bucket
Fork length	1067 mm (3'6")
Section width	80 mm (3")
Assembly weight kg (lb)	150 (330)
Max. operating height	3097 mm (10'2")
Reach at ground level	2660 mm (8'9")
Reach at full height	2251 mm (7'5")
S.W.L. at 500mm load centre kg (lb)	1000 (2204)

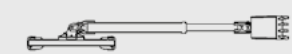
SIDESHIFT BACKHOE (Load chart for Extending Dipperstick using boom cylinder for lifting)	3.2 m (10'6")	4.1 m (13'5")	4.7 m (15'5")	5.2 m (17'1")	5.8 m (19')	6.1 m (20')
---	------------------	------------------	------------------	------------------	----------------	----------------

	1269 kg (2798 lbs)	1163 kg (2564 lbs)	829 kg (1828 lbs)	846 kg (1865 lbs)	743 kg (1638 lbs)	578 kg (1274 lbs)
	1076 kg (2372 lbs)	1163 kg (2564 lbs)	829 kg (1828 lbs)	334 kg (736 lbs)	265 kg (584 lbs)	562 kg (1239 lbs)
	801 kg (1766 lbs)	974 kg (2147 lbs)	762 kg (1680 lbs)	610 kg (1345 lbs)	524 kg (1155 lbs)	416 kg (917 lbs)

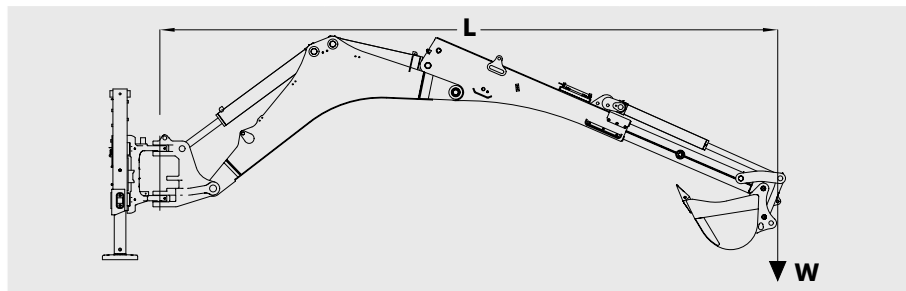



Backhoe Configuration (Top to Bottom)

- Centrally located 'over end' lift capacity (within 45° either side of the machine centreline)
- Centrally located lift capacity through the full swing arc
- Fully offset lift capacity through the full swing arc

BACKHOE BUCKETS	Width mm (ins)	Capacity m³ (ft³)	Weight Kg (lbs)
Standard trenching	305 (12)	0.074 (2.62)	99 (218)
	450 (18)	0.120 (4.25)	114 (251)
	600 (24)	0.177 (6.26)	136 (300)
Heavy duty	750 (30)	0.236 (8.32)	157 (346)
	900 (36)	0.296 (10.44)	178 (392)
	305 (12)	0.084 (2.96)	112 (247)
	450 (18)	0.140 (4.96)	128 (282)
	600 (24)	0.203 (7.15)	152 (335)
	750 (30)	0.266 (9.38)	174 (383)
Ditch cleaning	900 (36)	0.330 (11.66)	198 (436)
	1500 (60)	0.262 (9.2)	180 (397)
Trapezoidal	1800 (72)	0.317 (11.2)	204 (450)
	1200 (48)	0.258 (9.1)	146 (322)

LOADER BUCKETS	Standard Bucket	7 in 1 Bucket
Width	2386 mm (7'8")	2386 mm (7'8")
Capacity m³ (yd³)	1.2 (1.57)	1.2 (1.57)
Weight kg (lbs)	430 (948)	430 (948)

SIDESHIFT BACKHOE (Load Chart for Standard Dipperstick using boom cylinder for lifting)	3.2 m (10'6")	3.8 m (12'6")	4.3 m (14'1")	4.6 m (15'1")	5.0 m (16'5")
--	------------------	------------------	------------------	------------------	------------------

	1117 kg (2463 lbs)	1319 kg (2908 lbs)	1153 kg (2542 lbs)	1058 kg (2332 lbs)	979 kg (2158 lbs)
	1151 kg (2538 lbs)	1335 kg (2943 lbs)	1207 kg (2661 lbs)	1067 kg (2352 lbs)	956 kg (2108 lbs)
	803 kg (1770 lbs)	981 kg (2163 lbs)	819 kg (1806 lbs)	732 kg (1614 lbs)	665 kg (1466 lbs)

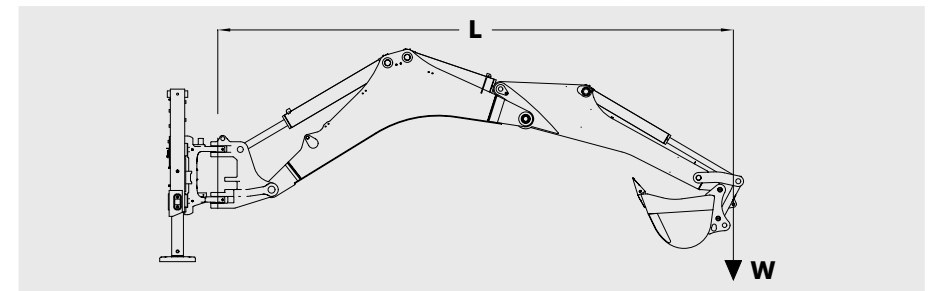

Note

- Standard 600 mm (24") bucket fitted, for larger buckets subtract difference in weight from stated lift capacity
- Figures stated are rated capacities, and are the lower of either the rated hydraulic lift capacity, or rated tipping load
- Figures in bold print are stability limited figures

STANDARD AND OPTIONAL EQUIPMENT

ENGINE (EU STAGE V / U.S. EPA TIER 4 FINAL*)

Perkins 904J-E36TA
Wastegate turbo and charge air cooled
Electric fuel pump
Electronic fuel injection
4 Glow plug starting aid
Vertical spin on oil filter
Primary fuel filter with water separator
500 hour service period
Oil to water internal plate oil cooler
Engine gradeability fore/aft and side/side: 30°
Anti-freeze rated to -37°C
Coolant header tank
Alternator and fan drive by polygroove belt with auto tensioner
Gear driven water pump
Puller type 9 bladed cooling fan
Dual element Powercore air cleaner
Stainless steel muffler and Exhaust Stack (DOC, SCR & DPF Exhaust System)

ENGINE OPTIONS

Fan guard

DRIVE LINE

Synchro shuttle transmission 4F/4R speeds
Direction control with neutral safety interlock
Transmission de-clutch on gear and loader controls
Removable transmission oil cooler
Vertical element oil filter
Foot operated electro/hydraulic differential lock
Outboard Planetary final drive axles
Large capacity outboard oil immersed disc brakes
• 2 Kevlar friction discs (289 mm dia) per side
• Total friction area per side 1238 cm ² (192 in ²)
Brakes self adjusting and self equalising
Dual brake pedals with combined or independent use
Internal wet disc parking brake
• Max Parking Slope (unladen) 1:2
• Max Parking Slope (laden) 1:2.5
Hydrostatic steering with emergency manual operation

4WD standard
Selectable 2 and 4 wheel braking

DRIVE LINE OPTIONS

Servo power synchro (SPS) transmission 4F/3R speeds
Column mounted rotational control lever
Automatic shifting between 4th, 3rd and 2nd
Kick down 2/1 and Kick up 1/2
Torque Converter stall ratio 3.01:1 (Standard SPS)

CAB AND CANOPY

ROPS/FOPS conform to ISO 3471/3449
Self cleaning footsteps and large grab handles
Internal rear view mirror
Folding external rear view mirrors
2 cup holders
Coat hook
Tilt and Telescopic steering wheel
Front and rear horn
Seat storage for operators manual
2 in (51 mm) retractable seat belt
3 auxiliary 12 volt outlets
Cab with 2 door access
Partial door locking
Opening rear quarter windows with internal operation
Full depth up and over rear window
Laminated windscreen
Tinted toughened safety glass
Front and rear screen washers and wipers
Standard fabric seat with mechanical suspension
Rotary hand throttle
Heater (7.37 kW)
Lockable chilled storage box
Digital clock
Cell phone holder with power plug
Pre installation of wiring for radio
Internal noise level 78 dB(a)
37 warnings either visual or audible
Engine hour meter
4 front and 4 rear LED worklights

4 Gauges for fuel level, engine coolant temperature, adblue level and rpm
2 external power sockets for beacon

CAB OPTIONS

Air conditioning (7.6 kW cooling)
Automatic Temperature Control
Premium high back seat, heated with air suspension
3 in 1 seat belt
Speedometer
Radio kit

LOADER

Mechanical - Hydraulic Anti-spill
Control lever with transmission disconnect and pump dump buttons
Single bucket cylinder
Bucket cylinder cushioning
Return to dig
Float position with positive hold
Bucket level indicator
Integral Loader arm safety bar
Standard bucket 1 m ³ with lifting eye
7 in 1 bucket 1 m ³ with lifting eye
Bucket teeth or bolt on reversible cutting edge
7 in 1 bucket operation by thumb slider control

LOADER OPTIONS

Standard bucket 1.2 m ³ with lifting eye
7 in 1 bucket 1.2 m ³ with lifting eye
Pallet forks with safe working load of 1000 kgs
3rd hydraulic line with standard bucket
Hose burst valves
Ride control
Bucket tooth guard
Mechanical or hydraulic quick attach

BACKHOE

Straight style boom
Standard dipperstick
Externally adjustable lubrication free wear pads (8)
Cable operated dual transport lock
Externally adjustable stabiliser wear pads
SAE/ISO/Diagonal lever controls
Standard trenching buckets with reversible side cutters

BACKHOE OPTIONS

Inner slide extendable dipperstick
Stabiliser lock out valves
Boom and Dipper hose burst valves
Hydraulic and Mechanical quick attach
Auxilliary circuit with single and double acting operation
HD buckets with power and speed positions
Quick release rubber street pads

GENERAL POINTS

Heavy duty chassis construction
Lockable side mounted toolbox
Fully tilting engine hood
Lifting eyes and Tie downs (2 front and rear)
Tandem gear pump hydraulics with mechanically operated backhoe controls

OPTIONS

Reverse Warning Alarm
Front Fenders
Premium Brand Tyres
Front hard nose counterweight

* Environmental Protection Agency (EPA) - Depending on your Local Legislation

Standard and optional equipment may vary. Consult your Mecalac dealer for details.

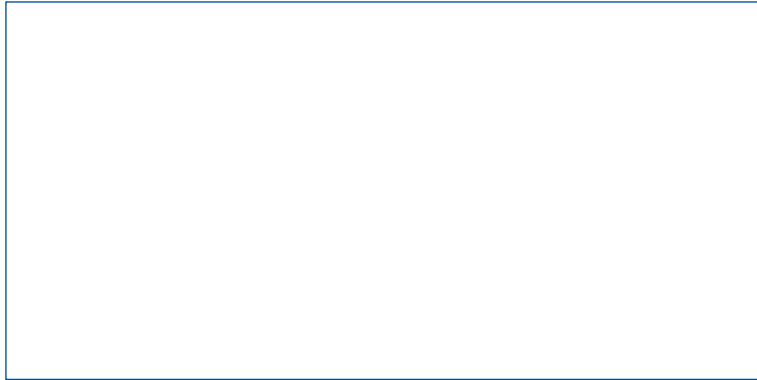

MECALAC FRANCE S.A.S.
2, avenue du Pré de Challes
Parc des Glaisins – CS 40230
Annecy-le-Vieux
FR - 74942 Annecy Cedex
Tel. +33 (0)4 50 64 01 63

**MECALAC BAUMASCHINEN
GMBH**
Am Friedrichsbrunnen
D-24782 Büdelsdorf
Tel. +49 (0)43 31/3 51-319

**MECALAC CONSTRUCTION
EQUIPMENT UK LTD**
Unit 1, Mallory Way
Gallagher Business Park
Coventry, CV6 6PB, UK
Tel. +44 (0)24 7633 9400

**MECALAC İŞ MAKİNELERİ
SAN. VE TİC. LTD. ŞTİ.**
Ege Serbest Bölgesi
Zafer SB Mahallesi Gündüz Sokak No:17/1
35410, Gazimür - İzmir - TÜRKİYE
Tel. +90 232 220 11 15



WWW.MECALAC.COM